

PROTOCOL®

SLIPSTREAM S™

RC STUNT DRONE

INSTRUCTION MANUAL



THANK YOU.

Thank you for your purchase of Protocol's **Slipstream S RC Stunt Drone**. You are about to experience the best of what remote control flight has to offer. We strongly recommend that you take the time to read this manual thoroughly. It contains many tips and instructions on how to get the most out of this aircraft and maintain it for a long life.

As with any aircraft, this is a precision flying machine. Treat it well and enjoy all the fun it has to offer, flight after flight.

TABLE OF CONTENTS

01	Safety & Precautions
02	Parts
04	Remote Battery Installation
05	Charging the Drone
06	Start-Up Procedure
07	Operation
09	Tips on 360° Flips
11	Speed Modes
12	Trim Adjustment
13	Troubleshooting
15	Flying Outdoors
16	Replacement Parts & Limited Warranty

SAFETY WARNINGS

HAVE FUN, BUT SAFETY FIRST!

- Read and follow instructions on how to synchronize electronics before each flight.
- To prevent damage to people or property, always avoid contact with other objects while in flight.
- Inspect aircraft prior to each flight and do not fly if damaged.
- Never expose product or any of its electronic parts to moisture, water, or heat sources.
- To prevent overheating, allow battery a cool-down period before recharging.
- To prolong engine life, allow a cool-down period between flights.
- Use only the charger and/or charging cable that is supplied with this item.
- Do not strike, cut, or pierce the internal battery or subject it to hard impacts.
- Do not mix old and new batteries or mix different types of batteries.
- Never attempt to modify function of vehicle or controller or attempt repairs using parts other than those supplied by Protocol. Spare parts are available at www.ProtocolNY.com

**THIS DEVICE USES COMPONENTS THAT OPERATE AT HIGH SPEEDS.
AS WITH ANY SUCH DEVICE, USE CAUTION TO OPERATE SAFELY.**

**FAILURE TO FOLLOW ANY OF THESE GUIDELINES MAY RESULT IN BODILY
INJURY OR DAMAGE TO PERSONAL OR PUBLIC PROPERTY.**

PARTS



DRONE

1. Canopy
2. Blade Guard
3. Blade
4. Battery Compartment

PARTS



REMOTE

1. Power Switch
2. Flip 360°
3. Forward/Backward
4. Bank Left/Right
5. Throttle
6. Turn Left/Right
7. Take Off/Landing
8. Trimmer (push in)
9. Speed Mode Selector
10. Lights On/Off

SPARE PARTS INCLUDED

- Replacement Blades

REMOTE BATTERY INSTALLATION

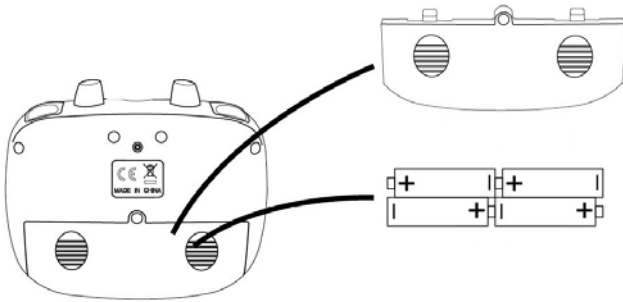

Remove battery cover from controller. Insert 4 x 'AA' batteries according to indicated polarities. Replace and screw back in battery cover.

1. Install batteries carefully.
2. Do not mix old and new batteries.
3. Do not mix different types of batteries.

CHARGING THE DRONE BATTERY

1. Remove the battery from the drone.
2. Connect the USB charging cable to the battery.
3. Plug the charger into a USB port. The USB light will turn on while charging and will turn off once fully charged.
4. Plug the battery back into the drone.
Charging time: 45 minutes --- Flying time: approximately 6 minutes

- * Low Battery Signal:
The lights on the drone will begin to flash in flight to indicate low battery.

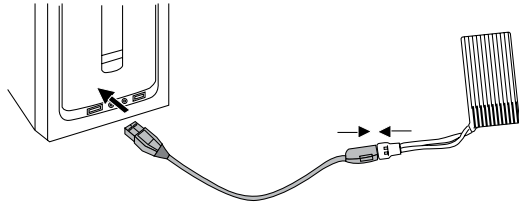

DO NOT CHARGE OVERNIGHT OR BEYOND THE CHARGING TIME STATED.
DO NOT LEAVE BATTERY UNATTENDED.

*Battery: Li-Po, 3.7V, 200mAh

If you purchased extra batteries, allow the engines to cool between flights in order to prolong engine life.

CAUTION WHEN CHARGING

1. When charging, place product on a dry, well-ventilated surface and keep away from heat sources.
2. Always use adult supervision while charging.
3. In order to increase battery longevity, avoid repeat charging and excessive discharging.
4. As battery temperature is high immediately after flight, charge after cooling down for higher efficiency.
5. Do not strike or subject battery to hard impacts or sharp surfaces.
6. Do not use any other charger than that which is supplied with this item.
7. Do not use or leave battery near a heat source such as fire or space heater; exposure to heat may result in reduced performance or in some cases dangerous conditions.
8. If battery is left in charging state for an extended period of time after being fully charged, the battery may automatically discharge.
9. Never leave the battery unattended during charging.
10. Do not disassemble battery.
11. Do not submerge battery in water.

START-UP PROCEDURE

Before flying, the drone and transmitter must be turned on in sequence and synchronized.

1. Plug the battery into the drone and place it on an even surface. The blue lights on the drone are at the front and the red are at the back.
2. Turn on the remote control.
3. Both indicators on the drone and the remote will flash while they are syncing.
4. Push the throttle up and then down to sync. You will hear two beeps and the lights will go steady to indicate the drone has synced.
5. Your drone is now synchronized, and in stand-by mode awaiting Engine Idle command.

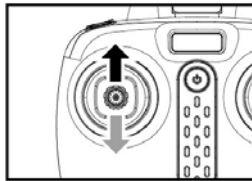

NOTE:

If after 30 seconds, it has not recognized the drone, turn off the controller and repeat Start-Up procedure.

STARTING THE ENGINE; ENGINE IDLE

After synchronizing the drone, move the throttle and direction sticks to the lower center corners and release to go into Idle mode. The blades will rotate but the drone will not lift.

OR

Push the throttle up and release to go into Idle Mode.

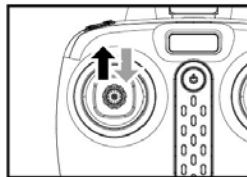
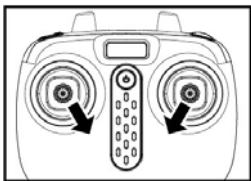

OPERATION: FLYING THE DRONE

TAKE-OFF:

1. Press the take off button. The remote will beep and the drone will hover a few feet off the ground. Then gently advance the throttle to a desired height and release. The drone will hover at that height.*

OR

2. From Idle mode, gently advance the throttle up to a desired height and release. The drone will hover at that height.*

LANDING:

1. Press the landing button to lower the drone to the ground.

OR

2. Push down on the throttle until the drone is on the ground.

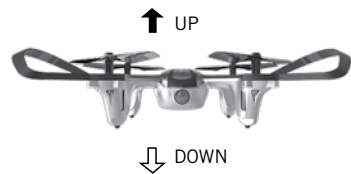

NOTE:

- The engine will shut off if you choose to hold the throttle down for 3 seconds.
- **Emergency Shut Off: When in flight, pull the throttle and direction stick to the center at the same time and the drone will shut off.**

* The drone may drift a bit, especially in the first 30 seconds until the altitude sensor gets a good fix on the position. Some drift is normal.



OPERATION: FLYING THE DRONE

FIRST TIME FLYERS!!! TAKE YOUR TIME! GO SLOW!

Practice hovering until you are comfortable with flight before attempting any other maneuvers. Make small movements letting the stick return to the center. If you start to lose control, don't panic. Just press land.



Pull the throttle left or right,
the drone turns to the left or right.

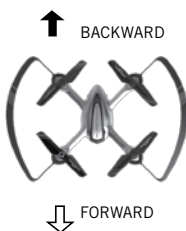

Push the direction lever up or down,
the drone flies forward or backward.



Pull the direction lever to the left or right,
the drone banks to the left or right.

TIPS ON 360° FLIPS

Once you have become skilled with the basics of drone flight, you can try some advanced maneuvers. At a height of at least 10 feet, press and hold the 360° Flip button and move the direction lever in any desired direction to execute the flip.

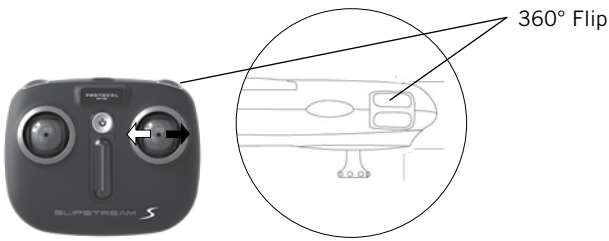

LEFT 360° FLIP

Push the direction stick to the left and the drone will perform a 360° flip in that direction.



RIGHT 360° FLIP

Push the direction stick to the right and the drone will perform a 360° flip in that direction.

TIPS ON 360° FLIPS



FORWARD 360° FLIP

Push the direction stick forward and the drone will perform a 360° flip in that direction.



BACKWARD 360° FLIP

Push the direction stick backward and the drone will perform a 360° flip in that direction.

SPEED MODES

The Slipstream S features two speed modes. Choose the speed based on flight experience and level of comfort. At high speed the drone will pitch more than at low speed. Slipstream S is quite fast at its high speed and requires more piloting skills to fly competently. For safety take time to develop advanced skills by practicing at low speed first. The drone is preset to low speed. Press the Speed button to change the speed mode.

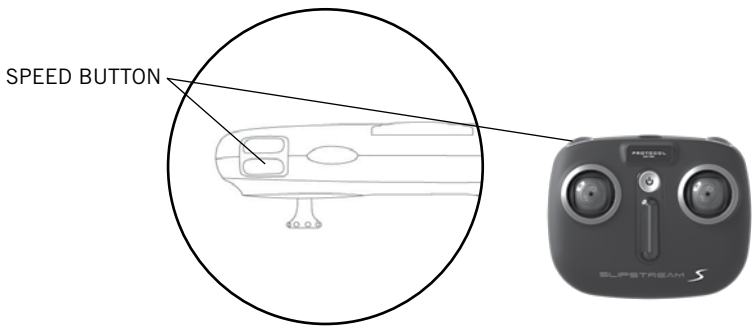

TRIM ADJUSTMENT

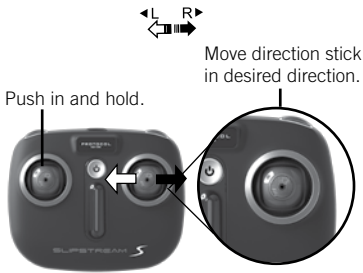

SIDEWAYS TRIM

When the drone drifts to the left or right side unintentionally, you can correct it by pushing in the throttle and moving the direction stick in the opposite direction until it evens out.

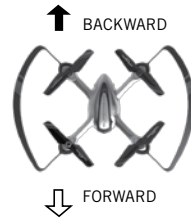
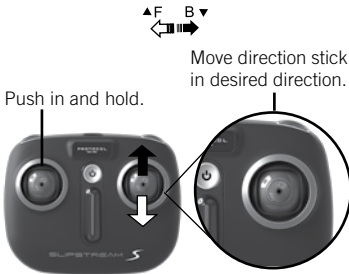

FORWARD/BACKWARD TRIM

When the drone drifts forward/backward unintentionally, you can correct it by pushing in the throttle and moving the direction stick in the opposite direction until it evens out.

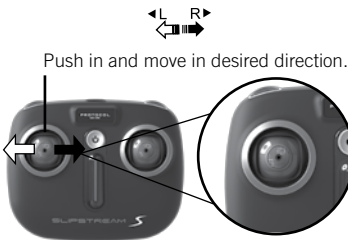

LEFT/RIGHT SPIN TRIM

When the drone spins left/right unintentionally, you can correct it by pushing in the throttle and moving it in the opposite direction until it evens out.

*NOTE: Trim adjustments are designed to counter drifts not caused by wind.

TROUBLESHOOTING

RE-CALIBRATING THE ALTITUDE SENSOR

If the drone crashes and after re-starting and trimming, it still is unstable, you have the option to re-calibrate the drone.

1. Turn on the drone and then the remote and sync.
2. Push and hold the throttle and direction sticks to the lower right corners.
3. The lights will flash and the remote will beep to indicate that the drone has re-calibrated.

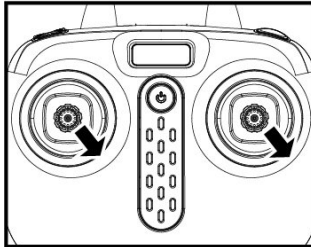

TROUBLESHOOTING

*Allow 15 minutes to pass between full flights as this will give the motors a chance to cool down. Failure to do so could wear out and shorten the life of the motors.

SYMPTOM	POSSIBLE CAUSE	POTENTIAL SOLUTION
Slipstream S does not respond	<ol style="list-style-type: none"> 1. Communication between controller and aircraft was not synchronized during set up 2. Battery power depleted on aircraft, controller or both. 	<ol style="list-style-type: none"> 1. To synchronize, turn on aircraft first, place it on level ground, and then turn on controller. 2. Charge aircraft and/or replace batteries in controller.
Response to control inputs intermittent or erratic	<ol style="list-style-type: none"> 1. Controller battery power nearly depleted. 	<ol style="list-style-type: none"> 1. Replace batteries in controller.
Slipstream S will not hover or strafe correctly	<ol style="list-style-type: none"> 1. The aircraft was not on level ground during synchronization. 2. Trim settings are incorrect. 	<ol style="list-style-type: none"> 1. Re-synchronize aircraft and controller. 2. Recalibrate the Altitude Sensor. 3. Re-trim flight controls.

HOW TO CHANGE THE BLADES

- All drones have two rotors that spin clockwise and two rotors that spin counter-clockwise.
- Make sure to place the blades on the correct axis or they will not spin correctly and the drone will not lift.
- Each blade is marked with 1 or 2.
- Make sure to follow the graphic below to see where to place the blades.

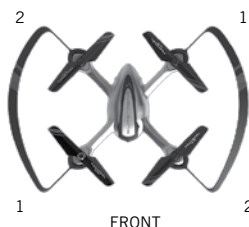

FLYING OUTDOORS

HOW TO PREVENT FLY AWAYS

To prevent “fly-away” situations (where drones seem to fly away out of control) it is important to first test and practice within close range before letting the drone fly too far away.

Each drone is designed to turn off the engines if the radio signal is lost. It is important to know and test the range of your drone before flying. We recommend turning on and syncing the drone and walking away while testing the engines. Keep walking and testing until it is obvious when you reach the point where the signal is not controlling the drone. This will be the control limit for the conditions in which you are flying. Distance does vary somewhat based on environmental and weather conditions, so testing the limit is advised. Fly in a range that is good for easy visual operation of the drone.

IF YOU CAN'T SEE YOUR DRONE, THEN YOU CAN'T CONTROL YOUR DRONE.

* Fly-aways are not covered by warranty as they are overwhelmingly caused by pilot error.

REPLACEMENT PARTS

Thank you for your purchase of Protocol's **Slipstream S RC Stunt Drone**. We know that accidents can sometimes happen and that is why we offer spare parts kits on our website: **ProtocolNY.com**.

LIMITED WARRANTY

At Protocol, we're dedicated to bringing you innovative and well-designed products that make living fun and easy. We stand behind all of our products and warrant this to be free from defects in workmanship and materials for 30 days from the date of purchase. The warranty does not cover transportation damage, misuse, accident, or similar events. Specific legal rights pertaining to this warranty may vary by state.

For service claims or questions please consult our website **www.ProtocolNY.com**.



